

NJD35N04G

NPN Darlington Power Transistor

This high voltage power Darlington has been specifically designed for inductive applications such as Electronic Ignition, Switching Regulators and Motor Control.

Features

- Exceptional Safe Operating Area
- High V_{CE} ; High Current Gain
- These are Pb-Free Devices

Benefits

- Reliable Performance at Higher Powers
- Designed for Inductive Loads
- Very Low Current Requirements

Applications

- Internal Combustion Engine Ignition Control
- Switching Regulators
- Motor Controls
- Light Ballast
- Photo Flash

MAXIMUM RATINGS

Rating	Symbol	Value	Unit
Collector-Emitter Sustaining Voltage	V_{CEO}	350	Vdc
Collector-Base Breakdown Voltage	V_{CBO}	700	Vdc
Collector-Emitter Breakdown Voltage	V_{CES}	700	Vdc
Emitter-Base Voltage	V_{EBO}	5.0	Vdc
Collector Current	I_C Continuous I_{CM} Peak	4.0 8.0	Adc
Base Current	I_B	0.5	Adc
Total Power Dissipation @ $T_C = 25^\circ\text{C}$ Derate above 25°C	P_D	45 0.36	W W/ $^\circ\text{C}$
Operating and Storage Junction Temperature Range	T_J, T_{stg}	-65 to +150	$^\circ\text{C}$

Stresses exceeding Maximum Ratings may damage the device. Maximum Ratings are stress ratings only. Functional operation above the Recommended Operating Conditions is not implied. Extended exposure to stresses above the Recommended Operating Conditions may affect device reliability.

THERMAL CHARACTERISTICS

Characteristic	Symbol	Value	Unit
Thermal Resistance	$R_{\theta JC}$ Junction-to-Case $R_{\theta JA}$ Junction-to-Ambient	2.78 71.4	$^\circ\text{C}/\text{W}$



ON Semiconductor®

<http://onsemi.com>

**DARLINGTON
POWER TRANSISTORS
4 AMPERES
350 VOLTS
45 WATTS**

MARKING DIAGRAM

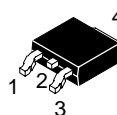

DPAK
CASE 369C
STYLE 1

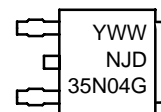

Y = Year
WW = Work Week
NJD35N04 = Device Code
G = Pb-Free Device

ORDERING INFORMATION

Device	Package	Shipping†
NJD35N04G	DPAK (Pb-Free)	75 Units / Rail
NJD35N04T4G	DPAK (Pb-Free)	2500/Tape & Reel

†For information on tape and reel specifications, including part orientation and tape sizes, please refer to our Tape and Reel Packaging Specification Brochure, BRD8011/D.

NJD35N04G

ELECTRICAL CHARACTERISTICS (T_C = 25°C unless otherwise noted)

Characteristic	Symbol	Min	Typ	Max	Unit
----------------	--------	-----	-----	-----	------

OFF CHARACTERISTICS

Collector–Emitter Sustaining Voltage (I _C = 10 mA, L = 10 mH)	V _{CEO(sus)}	350	–	–	Vdc
Collector Cutoff Current (V _{CE} = 500 V) (I _B = 0) (V _{CE} = 500 V, T _C = 125°C)	I _{CES}	–	–	50 250	μA _{dc}
Collector Cutoff Current (V _{CE} = 350 V) (I _B = 0) (V _{CE} = 300 V, T _C = 125°C)	I _{CEO}	–	–	50 250	μA _{dc}
Emitter Cutoff Current (V _{BE} = 5.0 Vdc)	I _{EBO}	–	–	5.0	μA _{dc}

ON CHARACTERISTICS

Collector–Emitter Saturation Voltage (I _C = 2.0 A, I _B = 20 mA) (I _C = 2.0 A, I _B = 20 mA 125°C)	V _{CE(sat)}	–	–	1.5	Vdc
Base–Emitter Saturation Voltage (I _C = 2.0 A, I _B = 20 mA) (I _C = 2.0 A, I _B = 20 mA 125°C)	V _{BE(sat)}	–	–	2.0	Vdc
Base–Emitter On Voltage (I _C = 2.0 A, V _{CE} = 2.0 V) (I _C = 2.0 A, V _{CE} = 2.0 V 125°C)	V _{BE(on)}	–	–	2.0	Vdc
DC Current Gain (I _C = 2.0 A, V _{CE} = 2.0 V) (I _C = 4.0 A, V _{CE} = 2.0 Vdc)	h _{FE}	2000 300	– –	– –	–

DYNAMIC CHARACTERISTICS

Current–Gain – Bandwidth Product (I _C = 2.0 A, V _{CE} = 10 V, f = 1.0 MHz)	f _T	90	–	–	MHz
Output Capacitance (V _{CB} = 10 V, I _E = 0, f = 0.1 MHz)	C _{ob}	–	60	–	pF

SWITCHING CHARACTERISTICS

V _{CC} = 12 V, V _{clamp} = 250 V, L = 4 mH I _C = 2 A, I _{B1} = 20 mA, I _{B2} = –20 mA	t _s t _f	– –	18 0.8	– –	μSec
---	----------------------------------	--------	-----------	--------	------

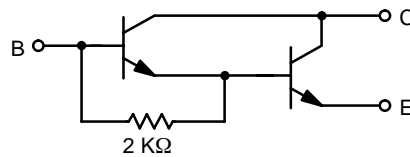

Figure 1. Darlington Circuit Schematic

NJD35N04G

TYPICAL CHARACTERISTICS

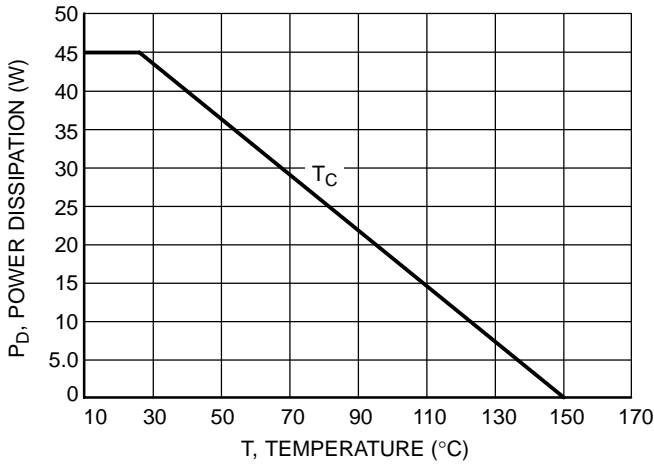

Figure 2. Power Derating

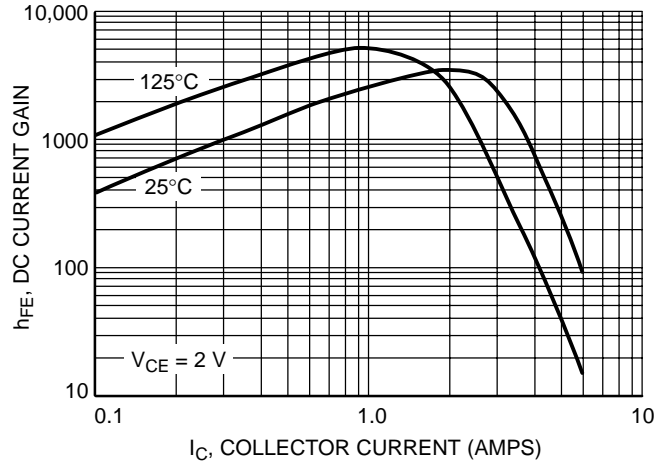

Figure 3. DC Current Gain

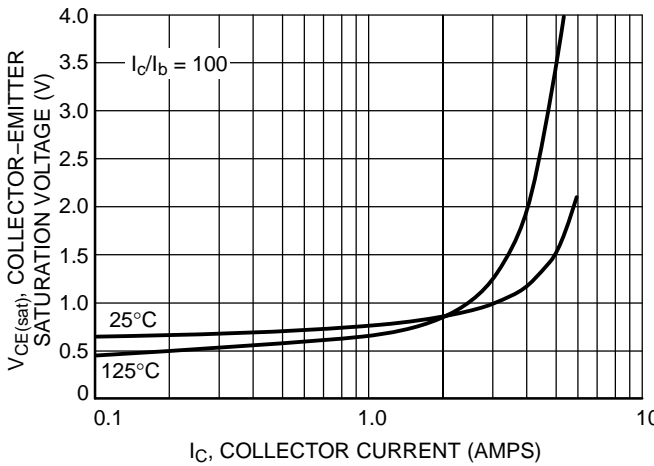

Figure 4. Collector-Emitter Saturation Voltage

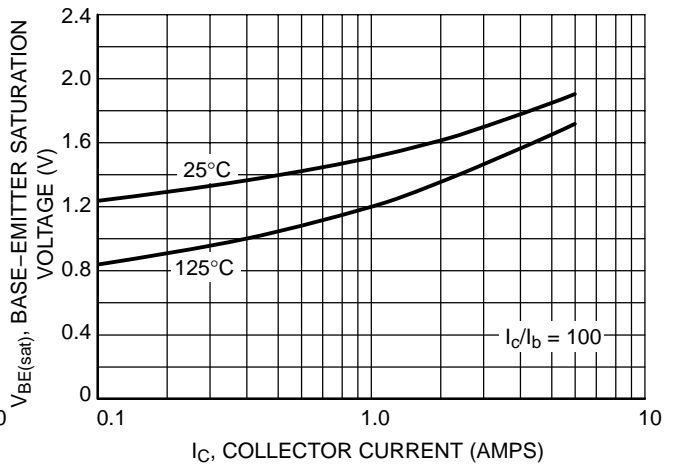

Figure 5. Base-Emitter Saturation Voltage

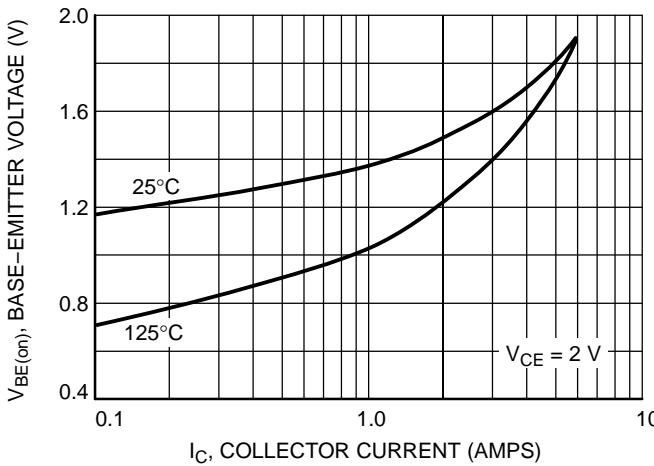

Figure 6. Base-Emitter Voltage

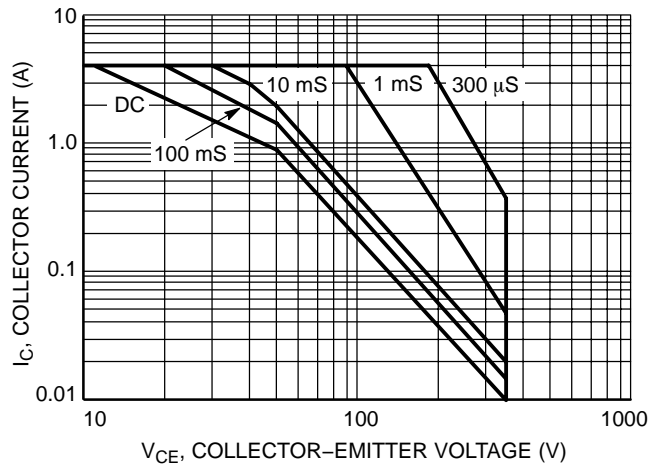
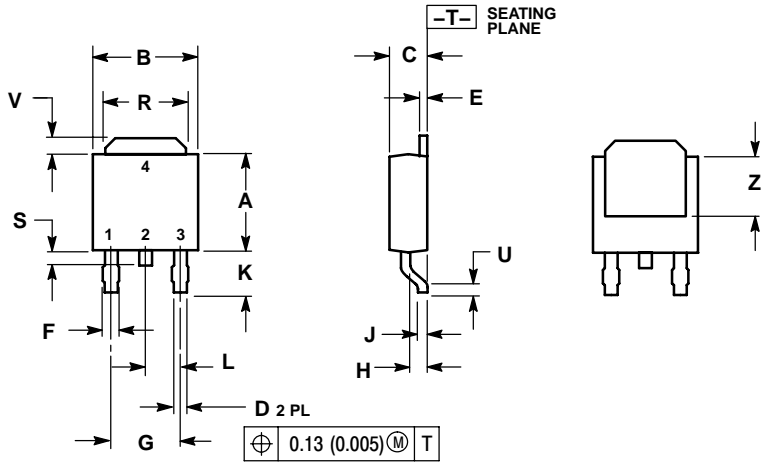

Figure 7. Forward Bias Safe Operating Area (FBSOA)

NJD35N04G

PACKAGE DIMENSIONS

DPAK
CASE 369C-01
ISSUE O



NOTES:

1. DIMENSIONING AND TOLERANCING PER ANSI Y14.5M, 1982.
2. CONTROLLING DIMENSION: INCH.

DIM	INCHES		MILLIMETERS	
	MIN	MAX	MIN	MAX
A	0.235	0.245	5.97	6.22
B	0.250	0.265	6.35	6.73
C	0.086	0.094	2.19	2.38
D	0.027	0.035	0.69	0.88
E	0.018	0.023	0.46	0.58
F	0.037	0.045	0.94	1.14
G	0.180 BSC		4.58 BSC	
H	0.034	0.040	0.87	1.01
J	0.018	0.023	0.46	0.58
K	0.102	0.114	2.60	2.89
L	0.090 BSC		2.29 BSC	
R	0.180	0.215	4.57	5.45
S	0.025	0.040	0.63	1.01
U	0.020	---	0.51	---
V	0.035	0.050	0.89	1.27
Z	0.155	---	3.93	---

STYLE 1:

1. BASE
2. COLLECTOR
3. EMITTER
4. COLLECTOR

SOLDERING FOOTPRINT*

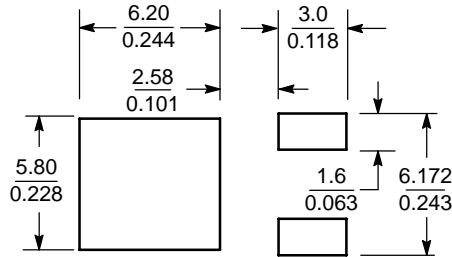

SCALE 3:1 (mm / inches)

*For additional information on our Pb-Free strategy and soldering details, please download the ON Semiconductor Soldering and Mounting Techniques Reference Manual, SOLDERRM/D.

ON Semiconductor and are registered trademarks of Semiconductor Components Industries, LLC (SCILLC). SCILLC reserves the right to make changes without further notice to any products herein. SCILLC makes no warranty, representation or guarantee regarding the suitability of its products for any particular purpose, nor does SCILLC assume any liability arising out of the application or use of any product or circuit, and specifically disclaims any and all liability, including without limitation special, consequential or incidental damages. "Typical" parameters which may be provided in SCILLC data sheets and/or specifications can and do vary in different applications and actual performance may vary over time. All operating parameters, including "Typicals" must be validated for each customer application by customer's technical experts. SCILLC does not convey any license under its patent rights nor the rights of others. SCILLC products are not designed, intended, or authorized for use as components in systems intended for surgical implant into the body, or other applications intended to support or sustain life, or for any other application in which the failure of the SCILLC product could create a situation where personal injury or death may occur. Should Buyer purchase or use SCILLC products for any such unintended or unauthorized application, Buyer shall indemnify and hold SCILLC and its officers, employees, subsidiaries, affiliates, and distributors harmless against all claims, costs, damages, and expenses, and reasonable attorney fees arising out of, directly or indirectly, any claim of personal injury or death associated with such unintended or unauthorized use, even if such claim alleges that SCILLC was negligent regarding the design or manufacture of the part. SCILLC is an Equal Opportunity/Affirmative Action Employer. This literature is subject to all applicable copyright laws and is not for resale in any manner.

PUBLICATION ORDERING INFORMATION

LITERATURE FULFILLMENT:
Literature Distribution Center for ON Semiconductor
P.O. Box 61312, Phoenix, Arizona 85082-1312 USA
Phone: 480-829-7710 or 800-344-3860 Toll Free USA/Canada
Fax: 480-829-7709 or 800-344-3867 Toll Free USA/Canada
Email: orderlit@onsemi.com

N. American Technical Support: 800-282-9855 Toll Free
USA/Canada

Japan: ON Semiconductor, Japan Customer Focus Center
2-9-1 Kamimeguro, Meguro-ku, Tokyo, Japan 153-0051
Phone: 81-3-5773-3850

ON Semiconductor Website: <http://onsemi.com>

Order Literature: <http://www.onsemi.com/litorder>

For additional information, please contact your local Sales Representative.